

# **Quick Strat**

## **SDM3065X Digital Multimeter**

QS06036-E01A



## Copyright Information

- SIGLENT TECHNOLOGIES CO., LTD. All rights reserved.
- The information provided in this manual replaces all information printed before.
- SIGLENT Company has the rights to change the specification and the price.
- Contents in this manual are not allowed to be copied, extracted and translated without permission by the company.

## General Safety Summary

Read the following safety precautions carefully to avoid any personal injuries or damages to the instrument and any products connected to it. To avoid potential hazards, please use the instrument as specified.

### **Use proper power line.**

It's only allowed to use the special power line which is approved by local state.

### **Ground the instrument.**

The instrument is grounded through the protective terra conductor of the power line. The ground conductor must be connected to the earth to avoid electric shock. Make sure the instrument is grounded correctly before connecting its input or output terminals.

### **Connect the signal wire correctly**

The potential of the signal wire is equal to the earth, so do not connect the signal wire to a high voltage.

### **Observe all terminal ratings**

Please observe all ratings and sign instructions on the instrument to avoid fire or electric shock. Before connecting the instrument, please read the manual carefully to gain more information about the ratings.

### **Do not operate with suspected failures**

If you suspect that the product is damaged, please contact SIGLENT's qualified service personnel to inspect it. Any repair and adjustment to the product or replacing a component should be done by qualified personnel only.

**Avoid circuit or wire exposure**

Don't touch exposed contacts or components when the power is on.

**Don't operate without covers.**

Don't operate the instrument with covers or panels removed.

**Use proper fuse.**

It's only allowed to use the specified fuse for the instrument.

**Use proper overvoltage protection.**

Make sure there is no overvoltage (like voltage caused by thunder and lightning) reaching to the instrument, otherwise the operator may suffer an electric shock.

**Antistatic protection.**

Static electricity will cause damages to the instrument, so test in antistatic areas as far as possible. Ground its inner and outer conductors to release the static electricity temporarily before connecting the cable to the instrument.

**Keep good ventilation.**

Improper ventilation will cause the rise of the instrument's temperature. Keep good ventilation and check the vent and fan regularly when using it.

**Keep the surface of the instrument clean and dry.****Do not operate in wet or damp conditions.****Do not operate in flammable or explosive environment.****The disturbance test of all the models meets the limit values**

of A in the standard of EN 61326-1:2013.

### Input terminal protection limitation

Protection limitation is defined for the input terminal:

#### 1. Main input (HI and LO) terminal

**HI** and **LO** terminals are used for Voltage, Resistance, Capacitance, Continuity, Frequency, Diode and temperature measurement. Two protection limitations are defined:

- **HI-LO protection limitation:** 1000VDC or 750AVC. It's the maximum measurable voltage. The limitation can be expressed as 1000Vpk.
- **LO-ground protection limitation:** **LO** terminal can "float" 500Vpk relative to the ground safely. The maximum protection limitation of **HI** terminal relative to the ground is 1000Vpk. Therefore, the sum of the "float" voltage and the measured voltage can't exceed 1000Vpk.

#### 2. Sampling (HISense and LOSense) terminal

**HISense** and **LOSense** are used for 4-wire Resistance measurement. Two protection limitations are defined:

- **HISense-LOSense protection limitation:** 2000Vpk.
- **LOSense-LOSense protection limitation:** 2Vpk.

#### 3. Current input (I) terminal

**I** and **LO** terminals are used for current measurement. The maximum current which go through the **I** terminal is limited to 10A by the fuse on the back panel.

**NOTE:**

Voltage on the current input terminal corresponds to voltage on **LO** terminal. To keep good protection, only use the fuse of specified type and level to replace this fuse.

**IEC Measurement Category II Overvoltage Protection**

SDM3065X Digital Multimeter provides overvoltage protection for line-voltage mains connections meeting both of the following conditions to avoid the danger of electric shock:

1. The HI and LO input terminals are connected to the mains under Measurement Category II conditions as following.
2. The maximum line voltage of the mains is 600VAC.

**WARNING:**

IEC Measurement Category II includes electrical devices connected to mains at an outlet on a branch circuit, such as most small appliances, test equipments, and other devices that plug into a branch outlet or socket.

SDM3065X is capable of making measurements with the **HI** and **LO** inputs connected to mains in such devices (up to 600VAC) or the branch outlet itself. However, the **HI** and **LO** terminals of SDM3065X can't be connected to mains in permanently installed electrical devices such as the main circuit-breaker panels, sub-panel disconnected boxes and permanently wired motors. Such devices and circuits are prone to exceed the protection limits of SDM3065X.

**NOTE:**

Voltages above 600VAC only can be measured in circuits that are isolated from mains. However, there may be transient overvoltage in circuits that are isolated from mains. SDM3065X is able to withstand occasional transient overvoltage up to 4000Vpk. Please don't use this instrument to measure circuits that transient overvoltage may exceed this level



# Safety Terms and Symbols

**Terms in this manual.** Terms may appear in this manual:

**WARNING:** Warning statements indicate the conditions and behaviors that could result in injury or loss of life.

**CAUTION:** Caution statements indicate the conditions and behaviors that could result in damage to this product or other properties.

**CAT I (1000V):** IEC Measurement Category I. The highest measurable voltage is 1000Vpk in the **HI-LO** terminal.

**CAT II (600V):** IEC Measurement Category II. Inputs may be connected to mains (up to 600VAC) under Category II overvoltage conditions.

**Terms used on the instrument.** Terms may appear on the instrument:

**DANGER** indicates an injury or hazard that may immediately happen.

**WARNING** indicates an injury or hazard that may not immediately happen.

**CAUTION** indicates that a potential damage to the instrument or other property might occur.

**Symbols used on the instrument.** Symbols may appear on the instrument:



**Hazardous  
Voltage**



**Protective  
Earth Ground**



**Warning**



**Test  
Ground**



**Chassis  
Ground**

# Daily Maintenance and Cleaning

## Maintenance

When storing or placing the instrument, please avoid the liquid crystal display from direct sunlight for a long time.

### NOTE:

- To avoid damages to the instrument or test leads, please don't place them in mist, liquid or solvent.

## Cleaning

Please often clean the instrument and test leads according to the use of them.

- Wipe the external ash of the instrument and test leads by a soft rag. Be careful not to scratch the transparent plastic protective screen when cleaning the liquid crystal screen.
- Use a soft rag that has been soaked by water to clean the instrument after cutting off the power. Or use 75% isopropyl alcohol of water solvent to get a more thorough cleaning.

### NOTE:

- To prevent the surface of the instrument or test leads from damages, please don't use any corrosive or chemical cleaning reagents.

Please make sure the instrument is already dry before restarting it to avoid short circuits or personal injuries caused by water.

---

## Content

<b>Copyright Information</b> .....	I
<b>General Safety Summary</b> .....	II
<b>Safety Terms and Symbols</b> .....	VII
<b>Daily Maintenance and Cleaning</b> .....	VIII
<b>General Inspection</b> .....	1
<b>Appearance and Size</b> .....	2
<b>To adjust the Handle</b> .....	3
<b>Front Panel</b> .....	4
<b>Rear Panel</b> .....	7
<b>Start the Multimeter</b> .....	10
<b>User Interface</b> .....	11
<b>Measurement Connections</b> .....	12
<b>To Use the Built-in Help System</b> .....	15
<b>Troubleshooting</b> .....	16
<b>Contact SIGLENT</b> .....	17

# General Inspection

## 1. Inspect the shipping container.

Please keep the damaged container or cushioning material until the contents of the shipment have been checked for completeness and the instrument has passed both electrical and mechanical tests.

The consigner or carrier shall be liable for the damage to instrument resulting from shipment. **SIGLENT** would not be responsible for free maintenance/rework or replacement of the unit.

## 2. Inspect the instrument.

In case of any damage, or defect, or failure, notify your **SIGLENT** sales representative.

## 3. Check the Accessories.

Check the accessories according to the packing list. If the accessories are incomplete or damaged, please contact your **SIGLENT** sales representative.

# Appearance and Size

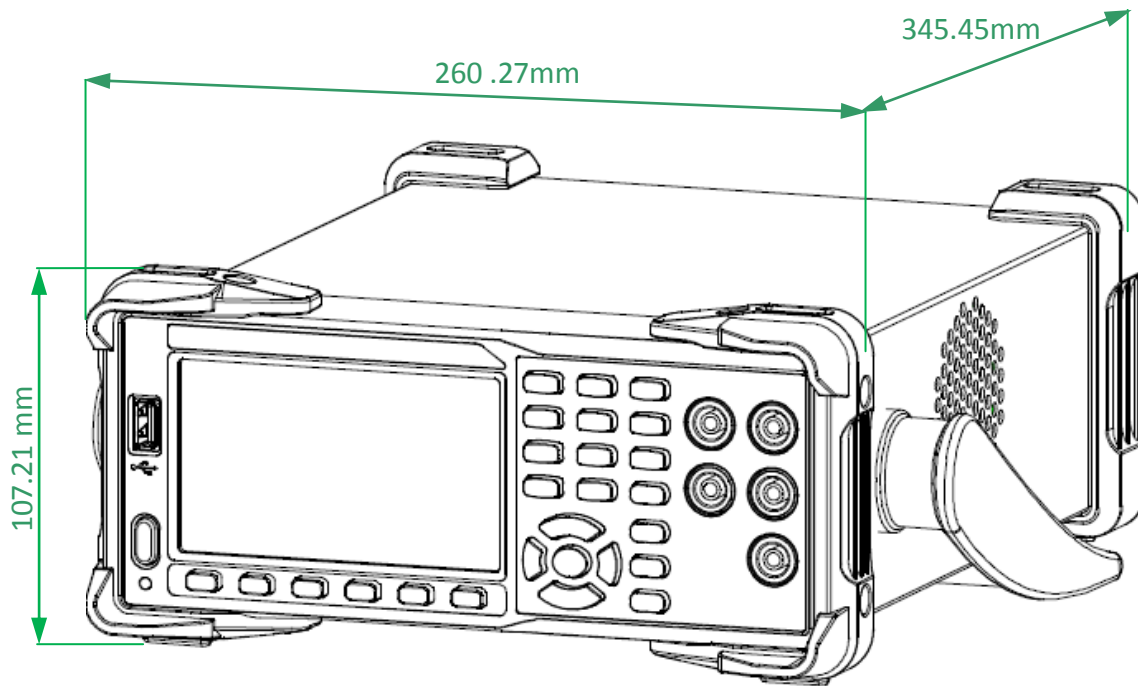

Appearance and Size

## To adjust the Handle

Please grip the handle by the two sides and pull it outward to adjust the handle position of SDM3065X. Then rotate the handle to the appropriate position. Please operate as the following figure:

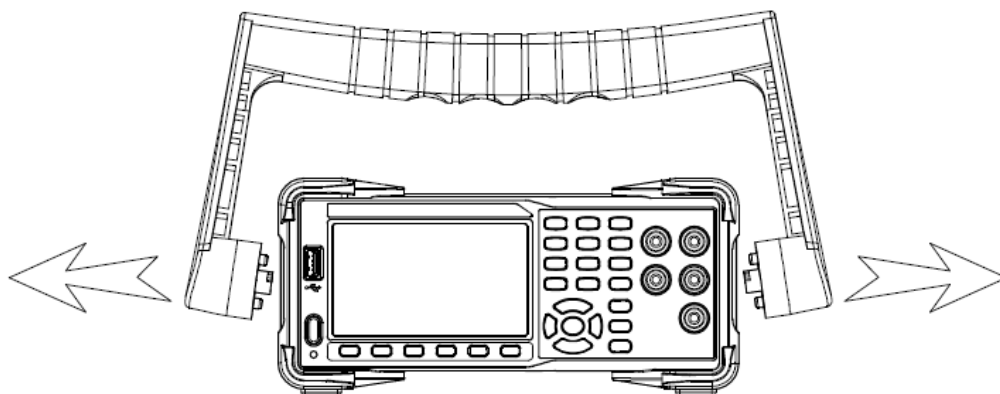

Handle Adjustment

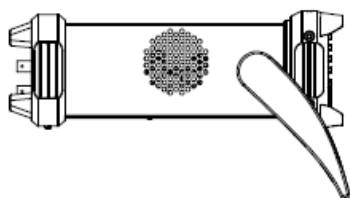
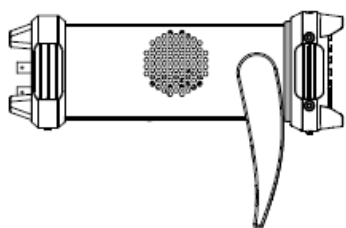
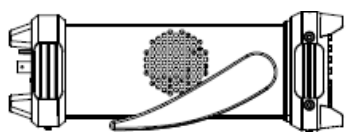

Horizontal Position

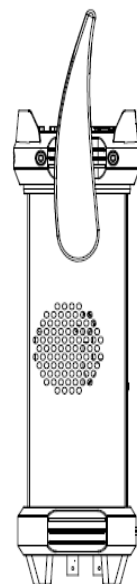

Carrying Position

# Front Panel

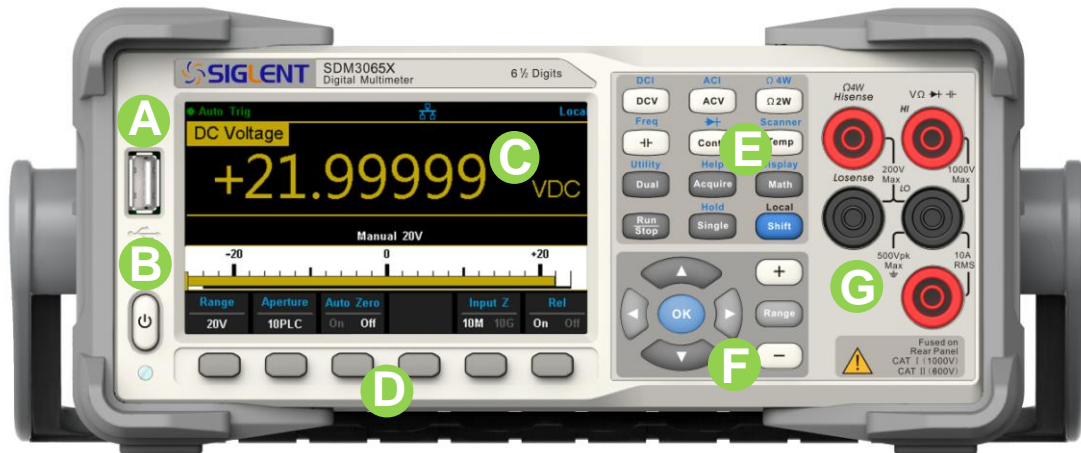

Front Panel Overview

## A USB Host

By using this interface, users can store the current state or measurement data into USB storage device. Users can also read the state files or updated firmware from USB storage device.

## B Power Key

Long/short press the key to turn on/off the instrument.

## C LCD Display









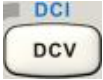

The instrument provides a 4.3 inch color TFT-LCD display screen with 480\*272 high resolutions that can the current function menus, measurement parameter settings, system status, prompt messages and so on.

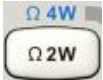
## D Menu Operation Keys

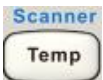
Press any softkey to activate the corresponding menu.



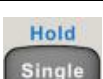





## E Measurement and Assistant Function Keys

## SIGLENT

	DC Voltage /Current Measurement
	AC Voltage/ Current Measurement
	2-Wire /4-Wire Resistance Measurement
	Frequency /Capacitance Measurement
	Continuity /Diode Test
	Temperature Measurement/ Enable Multiple Scan Card Function
	Enable Dual-display Function /Set Up the Utility
	Acquire Function /Help System
	Math Function /Display Function
	Auto Trigger/ Stop
	Single Trigger/ Hold Measurement Function
	<p>Return to local control of the instrument (when in Remote mode).</p> <p>Some of the front panel keys have text above them. This indicates that the key has a function that you can access by pressing and releasing [Shift] before pressing the key.</p>



## F Range and Direction Keys

	Increase the measurement range
	Decrease the measurement range
	Select auto or manual range
 	Set up measurement parameter Move the cursor Page or down
 	Set up measurement parameter Move the cursor
	Apply the current setting

## G Signal Input Terminals

The measured signal (device) will be connected into the multimeter through these terminals. Different measurement objects have different connection methods. For details, please refer to “**Measurement Connections**”.

## Rear Panel

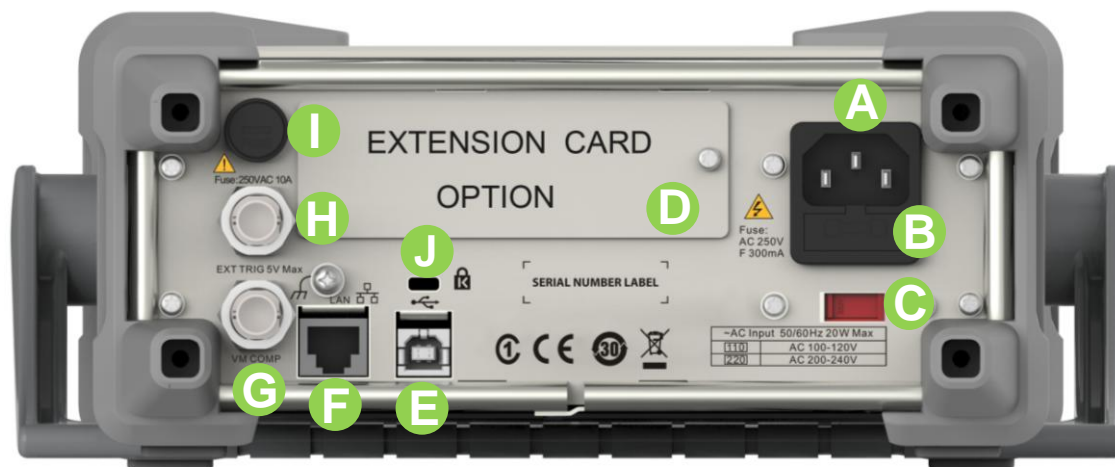

Rear Panel Overview

### **A** Power Socket

The multimeter accepts two types of AC supplies. Please use the power cord provided in the accessories to connect the multimeter to the AC power through this socket.

Note: a proper voltage scale must be first selected (through the Voltage Selector) before power connection.

### **B** Power Fuse

The multimeter is already installed with a power fuse before leaving factory. To replace a new one, please:

- 1) Turn off the multimeter and remove the power cord.
- 2) Press down the block tongue using a straight screwdriver (in the direction of the dotted arrow in the figure below) and pull out of the fuse seat.
- 3) Select a proper voltage scale.
- 4) Replace a specified fuse.
- 5) Reinstall the fuse seat into the slot.

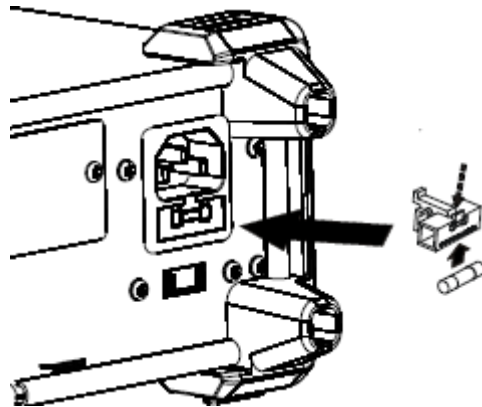

Change the fuse

**C AC Voltage Selector**

Select a proper voltage scale (110 V or 220 V) according to the AC supply used.

**D Inspection card (option)**

An optional 16-channel Data Acquisition Module can be installed in the instrument.

**E USB Device**

Connect the PC through this interface. You can use SCPI commands or PC software to control SDM3065X remotely.

**F LAN**

Through this interface, the multimeter can be connected to the network for remote control.

**G VMC Output**

The multimeter outputs a low-true pulse from the [VM Comp] connector after every measurement

### **H** Ext trigger

Trigger the multimeter by connecting a trigger pulse through the [Ext Trig] connector. Note the external trigger source must be selected.

### **I** Current Input Fuse

The multimeter is already installed with a current Input fuse to provide 10 A maximum input protection before leaving factory. To replace a new one, please:

- 1) Turn off the multimeter and remove the power cord.
- 2) Turn the fuse seat counterclockwise as shown in the figure using a straight screw driver and then pull out the fuse seat
- 3) Place a new specified fuse.
- 4) Reinstall the fuse seat into the slot.

### **J** Instrument Lockhole

You can use the safety lock to lock the multimeter in a fixed place if necessary.

## Start the Multimeter

Before connect the instrument to a power source, please select the AC voltage selector on the rear panel of your multimeter according to the power supply. Then connect the power cord as shown in the following figure.

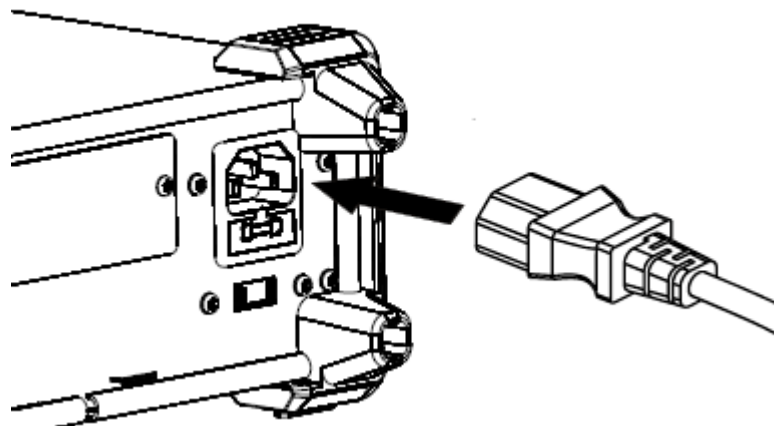

Connect Power Cord

Press the Power key on the front panel to start up the multimeter. If the multimeter does not starts normally, please:

1. Make sure the power cord is in good connection.
2. Try to restart the multimeter, if it fails, check the power fuse and replace a new one when necessary.
3. If the problem still remains, please contact **SIGLENT**.

# User Interface

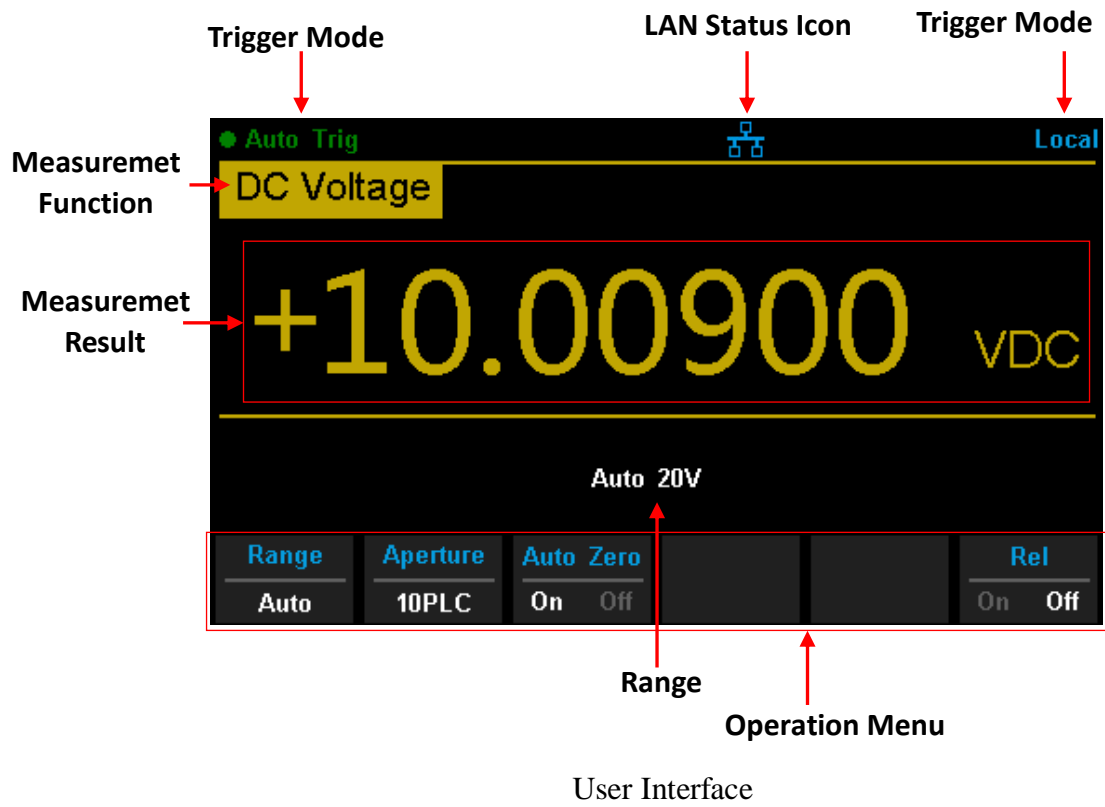

# Measurement Connections

SDM3065X is designed with many measurement functions. After selecting the desired measurement function, please connect the signal (device) under test to the multimeter according to the method below. Do not discretionarily switch the measurement function when measuring as it may cause damage to the multimeter. For example, when the test leads are connected to the related current terminals, AC voltage measurement should not be taken.

## DCV Measurement

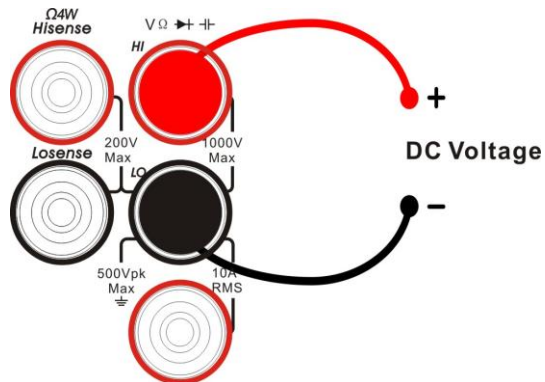

## ACV Measurement

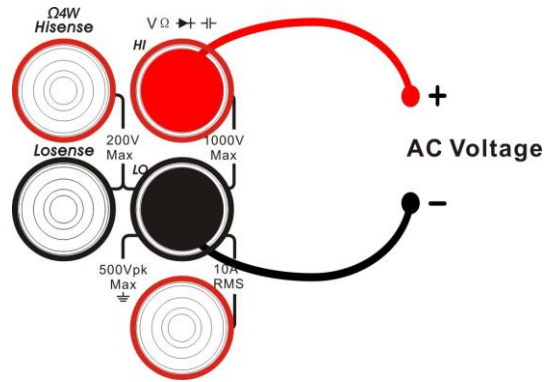

## DCI Measurement

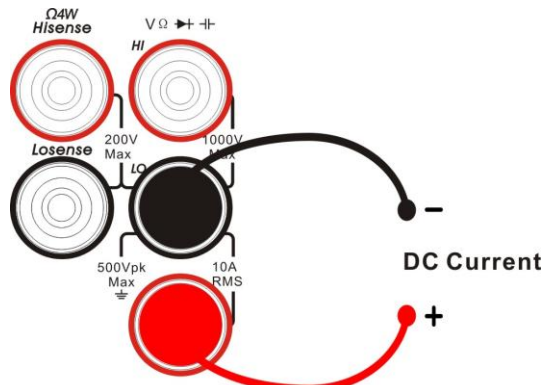

## ACI Measurement

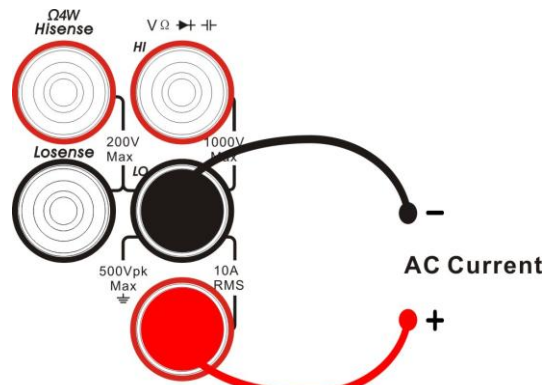

**Resistance Measurement (2-wire)**

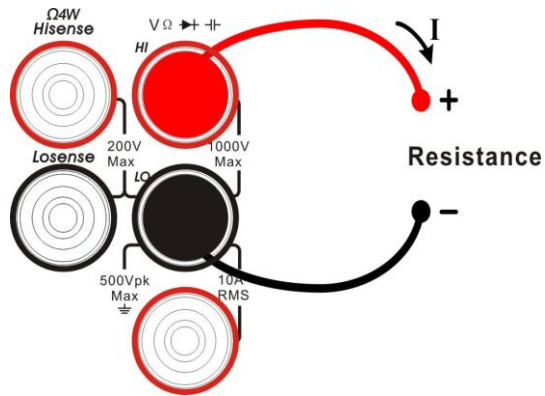

**Resistance Measurement (2-wire)**

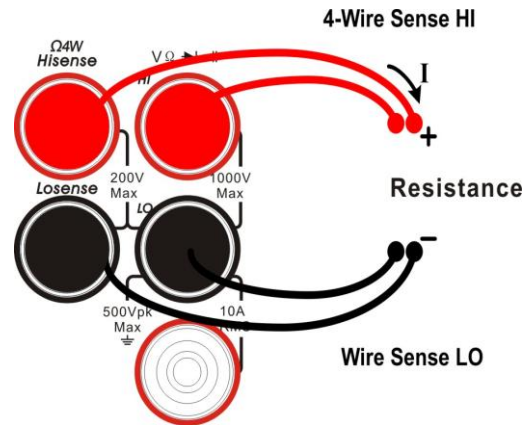

**Capacitance Measurement**

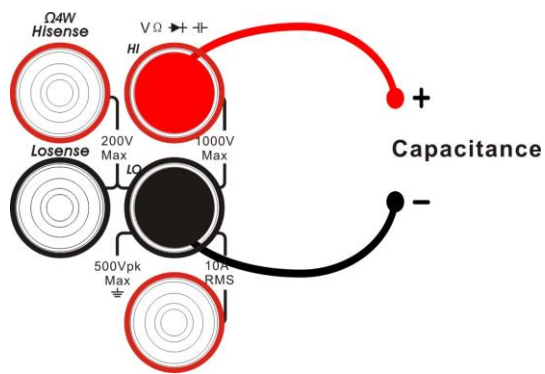

**Frequency/Period Measurement**

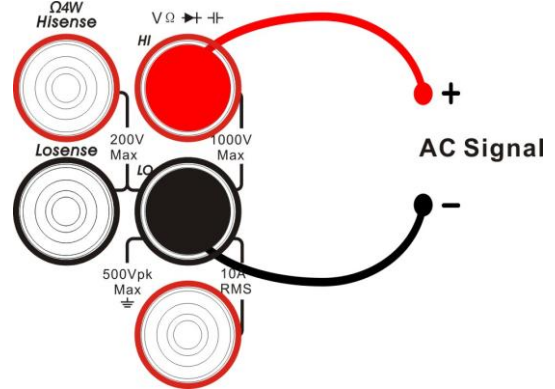

**Continuity Measurement**

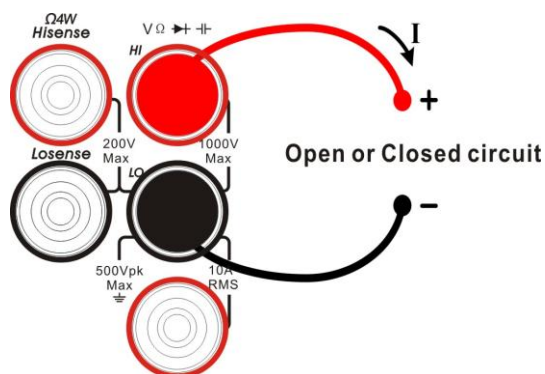

**Diode Measurement**

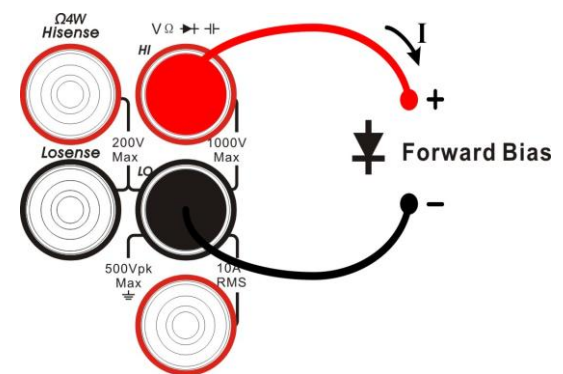



**Temperature Measurement**  
 (For RTD and thermocouple sensors)

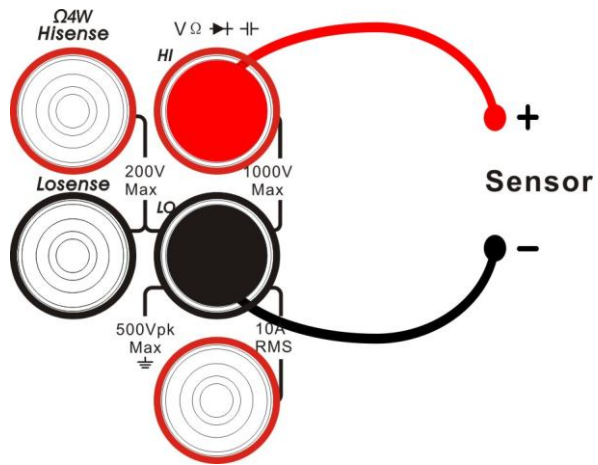

## To Use the Built-in Help System

To obtain built-in help information of the product, please press **【shift】+【Acquire】** to enter help system, then use the direction keys to choose the help item you want, finally press **【OK】** to obtain help information

The common help information is listed as the following:

1. Basic Measure.
2. Measuring Temperature.
3. Measuring Capacitance.
4. Math Function.
5. Dual-display Function.
6. Saving and Recalling Information.
7. Optional Multiple Scan Card.
8. The convention and Tips of Softkeys.
9. Technical Support.

---

# Troubleshooting

The commonly encountered failures and their solutions are listed below. When you encounter those problems, please solve them following the corresponding steps. If the problem remains still, please contact **SIGLENT** and provide your device information.

**1. If the screen is still dark with nothing displayed after pressing the power key.**

- 1) Check whether the power cord is well connected.
- 2) Check whether the power fuse is burned out. If the fuse needs to be changed, please use the specified fuse.
- 3) Restart the instrument after finishing the above inspections.
- 4) If the instrument still can't start up properly, please contact **SIGLENT**.

**2. The reading doesn't change when a current signal is input.**

- 1) Check whether the test lead is correctly inserted into the HI and LO terminals of current measurement.
- 2) Check whether the current fuse at the back panel is burned out.
- 3) Check whether the DCI or ACI measurement function is enabled.
- 4) Check whether the DCI measurement function is used to measure AC current.

**3. The reading is abnormal when a voltage signal is input.**

- 1) Check whether the test lead is correctly inserted into the HI and LO terminals of voltage measurement.
- 2) Check whether the the DCV or ACV measurement function is

enabled.

- 3) Check whether the DCV measurement function is used to measure AC voltage.

#### **4. The USB storage device cannot be identified.**

- 1) Check whether the USB storage device is in good condition.
- 2) Make sure the USB storage device you used is a flash storage device. This instrument does not support hardware storage type.
- 3) Check the capacity of your USB storage device. It is recommended that the capacity of the USB storage device is no larger than 8G bytes.
- 4) Restart the instrument and then insert the USB storage device.
- 5) If the problem persists, please contact **SIGLENT**.

## Contact SIGLENT

### **SIGLENT TECHNOLOGIES CO.,LTD**

Address: 3/F, building NO.4, Antongda Industrial Zone, 3rd Liuxian  
Road, Bao'an District, Shenzhen, P.R.China

Tel: 0086-755-3661 5186

E-mail: [sales@siglent.com](mailto:sales@siglent.com)

[Http://www.siglent.com](http://www.siglent.com)