

UNI-T®

**Model UT207/208
OPERATING MANUAL**

Table of Contents

Title	Page
Overview	4
Unpacking Inspection	5
Safety Information	6
Rules For Safe Operation	7
International Electrical Symbols	10
The Meter Structure	11
Functional Buttons	12
The Effectiveness of Functional Buttons	14
Display Symbols	15
Measurement Operation	18
A. DC/AC Voltage Measurement	18
B. Measuring Resistance	20
C. Testing Diodes	22
D. Testing for Continuity	24
E. Frequency Measurement	26
F. Duty Cycle Measurement	28

Title	Page
G. DC Current Measurement	30
H. AC Current Measurement	32
I. UT208 only: Temperature Measurement	35
Sleep Mode	37
Specifications	38
A. General Specifications	38
B. Environmental Requirements	39
Accuracy Specifications	40
A. DC Voltage	40
B. AC Voltage	41
C. Resistance	42
D. Diode Test	42
E. Continuity Test	43
F. Frequency	44
G. Duty Cycle	45
H. DC Current	45

Title	Page
I. AC Current	47
J. Temperature (UT208 only)	48
Maintenance	49
A. General Service	49
B. Replacing the Battery	50

Overview

This Operating Manual covers information on safety and cautions. Please read the relevant information carefully and observe all the **Warnings** and **Notes** strictly.



Warning

To avoid electric shock or personal injury, read the “Safety Information” and “Rules for Safe Operation” carefully before using the Meter.

Digital Clamp Multimeter **Model UT207/UT208** (hereafter referred to as “the Meter”) are 3 5/6 digits with steady operations, fashionable structure and highly reliable measuring instrument. The Meter uses large scale of integrated circuit with double integrated A/D converter as its core and has full range overload protection.

The Meter can measure AC/DC Voltage, AC/DC Current, Frequency, Duty Cycle, Resistance, Diodes, Continuity, Surge Current and etc.

UT208 has an extra temperature feature.

Unpacking Inspection

Open the package case and take out the Meter. Check the following items carefully to see any missing or damaged part:

Item	Description	Qty
1	English Operating Manual	1 piece
2	Test Lead	1 pair
3	Point Contact Temperature Probe (Only UT208) (This included point contact temperature probe can only be used up to 230°C. For any measurement is higher than that, the rod type temperature probe must be used)	1 pair
4	Tool box	1 piece
5	9V Battery (NEDA1604A or 6LF22)	1 piece

In the event you find any missing or damage, please contact your dealer immediately.

Safety Information

This Meter complies with the standards IEC61010-1; IEC61010-2-032: in pollution degree 2, overvoltage category (CAT. II 600V, CAT. III 300V) and double insulation.

CAT. II: Local level, appliance, PORTABLE EQUIPMENT etc., with smaller transient overvoltages than CAT. III.

CAT. III: Distribution level, fixed installation, with smaller transient overvoltages than CAT. IV

Use the Meter only as specified in this operating manual, otherwise the protection provided by the Meter may be impaired.

In this manual, a **Warning** identifies conditions and actions that pose hazards to the user, or may damage the Meter or the equipment under test.

A **Note** identifies the information that user should pay attention to.

International electrical symbols used on the Meter and in this Operating Manual are explained on page 10.

Rules For Safe Operation

Warning

To avoid possible electric shock or personal injury, and to avoid possible damage to the Meter or to the equipment under test, adhere to the following rules:











- Before using the Meter inspect the case. Do not use the Meter if it is damaged or the case (or part of the case) is removed. Look for cracks or missing plastic. Pay attention to the insulation around the connectors.
- Inspect the test leads for damaged insulation or exposed metal. Check the test leads for continuity. Replace damaged test leads with identical model number or electrical specifications before using the Meter.
- Do not apply more than the rated voltage, as marked on the Meter, between the terminals or between any terminal and grounding. If the value to be measured is unknown, use the maximum measurement position and reduce the range step by step until a satisfactory reading is obtained.
- When measurement has been completed, disconnect the connection between the test leads and the circuit under test, remove the testing leads away!

from the input terminals of the Meter and turn the Meter power off.

- The rotary switch should be placed in the right position and no any changeover of range shall be made during measurement is conducted to prevent damage of the Meter.
- Do not carry out the measurement when the Meter's back case and battery compartment are not closed to avoid electric shock.
Do not input higher than 600V between the two Meter's input terminal to avoid electric shock and damages to the Meter.
- When the Meter working at an effective voltage over 70V in DC or 33V rms in AC, special care should be taken for there is danger of electric shock.
- Use the proper terminals, function, and range for your measurements.
- Do not use or store the Meter in an environment of high temperature, humidity, explosive, inflammable and strong magnetic field. The performance of the Meter may deteriorate after dampened.
- When using the test leads, keep your fingers behind the finger guards.
- To avoid electric shock, do not touch the bare wires, connectors, unused input terminals or the circuit under testing during measurement.
- Disconnect circuit power and discharge all high-voltage capacitors before testing resistance, continuity and diode.

- Replace the battery as soon as the battery indicator  appears. With a low battery, the Meter might produce false readings that can lead to electric shock and personal injury.
- When servicing the Meter, use only the same model number or identical electrical specifications replacement parts.
- The internal circuit of the Meter shall not be altered at will to avoid damage of the Meter and any accident.
- Soft cloth and mild detergent should be used to clean the surface of the Meter when servicing. No abrasive and solvent should be used to prevent the surface of the Meter from corrosion, damage and accident.
- The Meter is suitable for indoor use.
- Turn the Meter off when it is not in use and take out the battery when not using for a long time.
- Constantly check the battery as it may leak when it has been using for some time, replace the battery as soon as leaking appears. A leaking battery will damage the Meter.

International Electrical Symbols

	AC (Alternating Current)
	DC (Direct Current)
	AC or DC
	Grounding
	Double Insulated
	Warning. Refer to the Operating Manual
	Deficiency of Built-In Battery
	Continuity Test
	Diode
	Danger of High Voltage
	Conforms to Standards of European Union

The Meter Structure (see figure 1)

1. Hand Guards: to protect user's hand from touching the dangerous area.
2. Trigger: press the lever to open the transformer jaws. When the pressure on the lever is released, the jaws will close.
3. Functional Buttons
4. Input Terminals
5. LCD Display
6. Rotary Switch
7. Transformer Jaw: designed to pick up the AC and DC current flowing through the conductor. It could transfer current to voltage. The tested conductor must vertically go through the Jaw center.

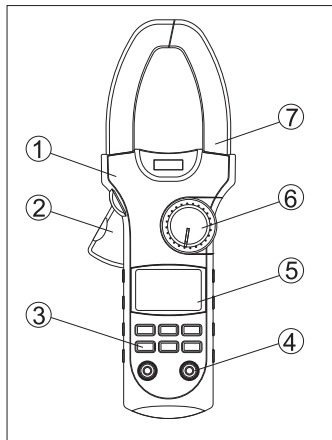



Figure 1

Functional Buttons

Below table indicated for information about the functional button operations.

Button	Operation Performed
SELECT	Press SELECT button to select the alternate functions including V_{\sim} , μV_{\sim} , \rightarrow , Ω , %Hz, A_{\sim} and °C °F (UT208 only).
MAX/MIN	Starts recording of maximum and minimum values. Press to step the display through high (MAX) and low (MIN) readings at any mode. <ul style="list-style-type: none"> ● Press and hold for one second to exit MAX/MIN mode.
	<ul style="list-style-type: none"> ● Press again to turn the display backlight off, otherwise it will automatically off after 1 minute.
HOLD	<ul style="list-style-type: none"> ● Press HOLD to enter the Hold mode in any mode, the Meter beeps. ● Press HOLD again to exit the Hold mode to return to measurement mode, the Meter beeps. ● Turn the rotary switch or press SELECT button can also exit Hold mode.

Model UT207/208: OPERATING MANUAL

Button	Operation Performed
HOLD	● Press HOLD button for 2 seconds when turning on the Meter to display full icon.
Hz	When the Meter is at %Hz, V \sim and A \sim , press Hz to measure frequency and duty cycle.
ZERO	Press ZERO to zeroing the display before measuring DC current.

The Effectiveness of Functional Buttons

Not every functional buttons can be used on every rotary switch positions. Below table describe which functional buttons can be used on which rotary switch positions

Rotary Switch Positions	Functional Buttons					
	SELECT	MAX/MIN		HOLD	Hz	ZERO
$\sqrt{\sim}$	•	•	•	•	•	N/A
$\cdot \parallel \rightarrow \Omega$	•	•	•	•	N/A	N/A
%Hz	N/A	•	•	•	•	N/A
66A \dots	N/A	•	•	•	N/A	•
1000A \dots	N/A	•	•	•	N/A	•
66A \sim	•	•	•	•	•	N/A
1000A \sim	•	•	•	•	•	N/A
$^{\circ}\text{C } ^{\circ}\text{F}$	•	•	•	•	N/A	N/A

Display Symbols (see figure 2)

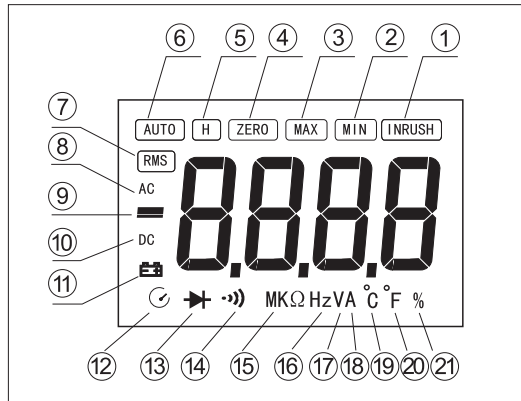





Figure 2

Number	Symbol	Meaning
1	INRUSH	Indicator for Surge current
2	MIN	Minimum reading displayed
3	MAX	Maximum reading displayed
4	ZERO	Indicator for zeroing
5	H	Data hold is active
6	AUTO	The Meter is in the auto range mode in which the Meter automatically selects the range with the best resolution.
7	RMS	True RMS indicator
8	AC	Indicator for AC voltage or current
9	—	Indicates negative reading
10	DC	Indicator for DC voltage
11		The battery is low. ⚠ Warning: To avoid false readings, which could lead to possible electric shock or personal injury, replace the battery as soon as the battery indicator appears.

Model UT207/208: OPERATING MANUAL

Number	Symbol	Meaning
12		Sleep mode is on
13		Test of diode
14		The continuity buzzer is on
15	$\Omega, K\Omega, M\Omega$	Ω : Ohm. The unit of resistance. k Ω :Kilohm. 1×10^3 or 1000 ohms M Ω :Megohm. 1×10^6 or 1,000,000 ohms
16	Hz, kHz, MHz	Hz: Hertz. The unit of frequency. KHz: Kilohertz. 1×10^3 or 1000 hertz. MHz: Megahertz. 1×10^6 or 1,000,000 hertz.
17	mV, V	Volts. The unit of voltage. mV: Millivolt. 1×10^{-3} or 0.001 volts
18	A	Amperes (amps). The unit of current.
19	$^{\circ}\text{C}$	The unit of temperature: $^{\circ}\text{C}$: Centigrade temperature
20	$^{\circ}\text{F}$	The unit of temperature: $^{\circ}\text{F}$: Fahrenheit temperature
21	%	Duty cycle measurement

Measurement Operation

A. DC/AC Voltage Measurement (see figure 3)

Warning

To avoid harms to you or damages to the Meter from electric shock, do not attempt to measure voltages higher than 600V AC/DC, although readings may be obtained.

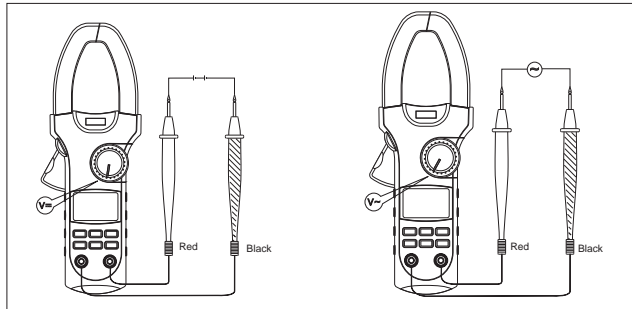



Figure 3

Model UT207/208: OPERATING MANUAL

The DC Voltage ranges are: 6.6V, 66V and 600V

The AC Voltage ranges are: 6.6V, 66V and 600V

To measure DC/AC voltages, connect the Meter as follows:

1. Insert the red test lead into the **VΩHz** terminal and black test lead into the **COM** terminal.
2. Set the rotary switch to **V** . DC measurement mode and auto ranging is a default. Press **SELECT** to switch to AC measurement mode.
3. Press **Hz** button to measure frequency or duty cycle, but the frequency or duty cycle readings obtained from this range is only for reference.
4. Connect the test leads across with the object being measured.
The measured value shows on the display.

Note

- When DC/AC voltage measurement has been completed, disconnect the connection between the testing leads and the circuit under test and remove testing leads from the input terminals.

B. Measuring Resistance (see figure 4)

Warning

To avoid damages to the Meter or to the devices under test, disconnect circuit power and discharge all the high-voltage capacitors before measuring resistance.

The resistance ranges are:
660 Ω , 6.6k Ω , 66k Ω , 660k Ω , 6.6M Ω and 66M Ω

To measure resistance, connect the Meter as follows:

1. Insert the red test lead into the **V Ω Hz** terminal and black test lead into the **COM** terminal.
2. Set the rotary switch to  Ω . Resistance measurement is a default or press **SELECT** to switch to Ω measurement mode.

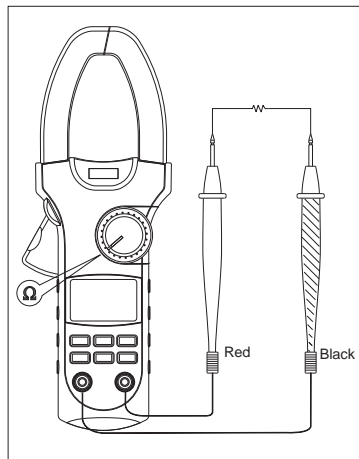

Figure 4

Model UT207/208: OPERATING MANUAL

3. Connect the test leads across with the object being measured.
The measured value shows on the display.

Note

- To obtain a more precise reading, you could remove the objects being tested from the circuit when measuring.
- When resistance measurement has been completed, disconnect the connection between the testing leads and the circuit under test and remove testing leads from the input terminals.

C. Testing Diodes (see figure 5)

Warning

To avoid damages to the Meter or to the devices under test, disconnect circuit power and discharge all the high-voltage capacitors before testing diodes.

Use the diode test to check diodes, transistors, and other semiconductor devices. The diode test sends a current through the semiconductor junction, then measure the voltage drop across the junction. A good silicon junction drops between 0.5V and 0.8V.

To test the diode out of a circuit, connect the Meter as follows:

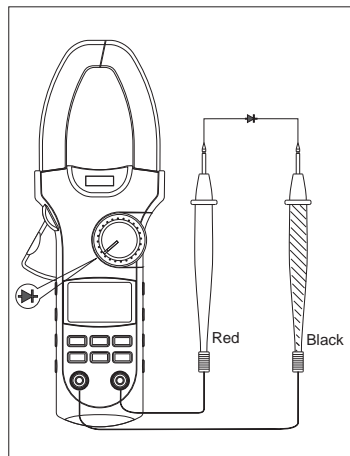

Figure 5

Model UT207/208: OPERATING MANUAL

1. Insert the red test lead into the **V Ω Hz** terminal and black test lead into the **COM** terminal.
2. Set the rotary switch to **V Ω Hz**. Press **SELECT** to switch to **V Ω Hz** measurement mode.
3. For forward voltage drop readings on any semiconductor component, place the red test lead on the component's anode and place the black test lead on the component's cathode.

Note



- To obtain a more precise reading, you could remove the objects being tested from the circuit when measuring.
- When diode testing has been completed, disconnect the connection between the testing leads and the circuit under test and remove testing leads from the input terminals.

D. Testing for Continuity (see figure 6)

Warning

To avoid damages to the Meter or to the devices under test, disconnect circuit power and discharge all the high-voltage capacitors before measuring continuity.

To test for continuity, connect the Meter as follows:

1. Insert the red test lead into the **VΩHz** terminal and the black test lead into the **COM** terminal.
2. Set the rotary switch to  and press **SELECT** button to select  measurement mode.
3. The buzzer sounds if the resistance of a circuit under test is less than 30Ω .
4. The buzzer may or may not sound if the resistance of a circuit under test is between 30Ω to 100Ω .
5. The buzzer does not sound if the resistance of

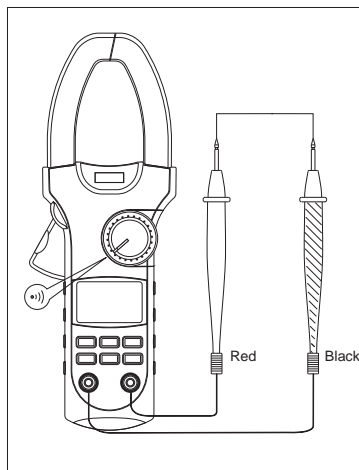

Figure 6

Model UT207/208: OPERATING MANUAL

a circuit under test is higher than 100Ω .

Note

- When continuity testing has been completed, disconnect the connection between the testing leads and the circuit under test and remove testing leads from the input terminals.

E. Frequency Measurement (see figure 7)

Warning

To avoid harms to you or damages to the Meter from electric shock, do not attempt to measure voltages higher than 600V AC/DC, although readings may be obtained.

The frequency ranges are:
660Hz, 6.6kHz, 66kHz, 660kHz, 6.6MHz and 66MHz.

To measure frequency, connect the Meter as follows:

1. Insert the red test lead into the **VΩHz** terminal and the black test lead into the **COM** terminal.
2. Set the rotary switch to **%Hz**. Frequency measurement mode is a default or press **SELECT** to switch to **Hz** measurement mode.
3. Connect the test leads across with the object

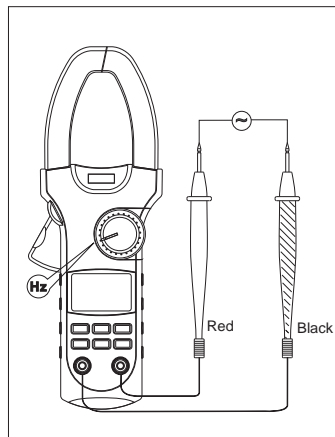

Figure 7

Model UT207/208: OPERATING MANUAL

being measured.

The measured value shows on the display.

Note

- When frequency measurement has been completed, disconnect the connection between the testing leads and the circuit under test, and remove the testing leads away from the input terminals of the Meter.

F. Duty Cycle Measurement (see figure 8)

Warning

To avoid harms to you or damages to the Meter from electric shock, do not attempt to measure voltages higher than 600V AC/DC, although readings may be obtained.

The duty cycle range is: 0.1%~99.9%.

To measure duty cycle, connect the Meter as follows:

1. Insert the red test lead into the **VΩHz** terminal and the black test lead into the **COM** terminal.
2. Set the rotary switch to **%Hz**. Press **SELECT** to switch to **%** measurement mode.
3. Connect the test leads across with the object being measured.

The measured value shows on the display.

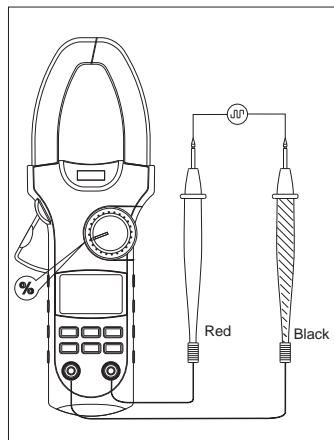

Figure 8

Note

- When duty cycle measurement has been completed, disconnect the connection between the testing leads and the circuit under test, and remove the testing leads away from the input terminals of the Meter.

G. DC Current Measurement (see figure 9)

The measurement ranges of current are: 66A $\overline{\text{A}}$ and 1000A $\overline{\text{A}}$.

To measure current, do the following:

1. Set the rotary switch to 66A $\overline{\text{A}}$ or 1000A $\overline{\text{A}}$.
2. Hold the Meter tight, don't release. The Hall components are very sensitive not only to the magnet but also to heat and machines reaction force. Any shock will cause the changing in reading in the short time.
3. Press the lever to open the transformer jaw.
4. Center the conductor within the transformer jaw, then release the Meter slowly until the transformer jaw is completely closed, Make sure the conductor to be tested is placed at the center of the transformer jaw, otherwise it will casue deviation. The Meter can only measure one

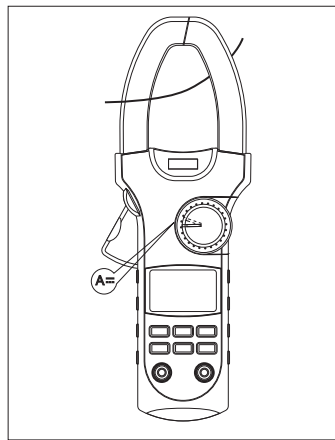

Figure 9

Model UT207/208: OPERATING MANUAL

conductor at a time, to measure more than one conductor at a time will cause deviation.

Note

- If the Meter does not display 00.00 when it is at 66A $\overline{\text{---}}$ range, press **ZERO** to zeroing. After zeroing, it allows 10 digits bouncing reading.
- When the Meter is at 1000A $\overline{\text{---}}$, it displays 0 and it is not allowed to press **ZERO** to zeroing.
- When current measurement has been completed, disconnect the connection between the conductor under test and the jaw, and remove the conductor away from the transformer jaw of the Meter.

H. AC Current Measurement (see figure 10)

Warning

The measurement ranges of current are: 66.00A \sim and 1000A \sim .

To measure AC current, do the following:

1. Set the rotary switch to 66A \sim or 1000A \sim .
2. Hold the Meter tight, don't release. The Hall components are very sensitive not only to the magnet but also to heat and machines reaction force. Any shock will cause the changing in reading in the short time.
3. Press the lever to open the transformer jaw.
4. Center the conductor within the transformer jaw, then release the Meter slowly until the transformer jaw is completely closed, Make sure the conductor to be tested is placed at the center of the

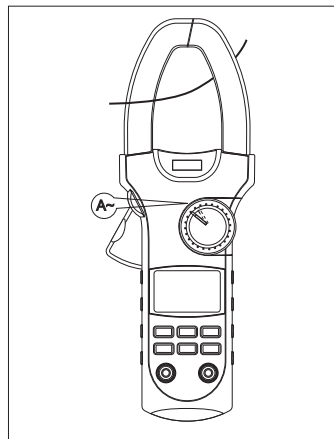

Figure 10

Model UT207/208: OPERATING MANUAL

transformer jaw, otherwise it will cause deviation. The Meter can only measure one conductor at a time, to measure more than one conductor at a time will cause deviation.

5. When the measuring current $>1A$, press **Hz** button to step through AC current, frequency and duty cycle measurement mode. But the frequency or duty cycle readings obtained from this range is only for reference.
6. Press **SELECT** to carry out surge current measurement.

To measure surge current Measurement, do the following:

1. Set the rotary switch to 1000A \sim .
2. Press **SELECT** when the Meter displays the minimum readings. The Meter then displays “-----” means it is ready to carry out surge current measurement.
3. Turn on the electrical equipments at that time to measure the moment start up current.
4. Press and hold **SELECT** for one second to exit surge current measurement mode.
5. When the Meter is at surge current measurement, it is locked to the highest measurement range.

Note

- When current measurement has been completed, disconnect the connection between the conductor under test and the jaw, and remove the conductor away from the transformer jaw of the Meter.

I. UT208 only: Temperature Measurement (see figure 11)

The temperature measurement range: $-40^{\circ}\text{C}\sim 1000^{\circ}\text{C}$
and $-40^{\circ}\text{F}\sim 1832^{\circ}\text{F}$.

To measure temperature measurement, connect the Meter as follows:

1. Insert the red temperature probe into the **V Ω Hz** terminal and the black temperature probe into the **COM** terminal.
2. Set the rotary switch to $^{\circ}\text{C}/^{\circ}\text{F}$. Press **SELECT** to switch between $^{\circ}\text{C}$ and $^{\circ}\text{F}$ measurement mode.
3. Place the temperature probe to the object being measured.

The measured value shows on the display.

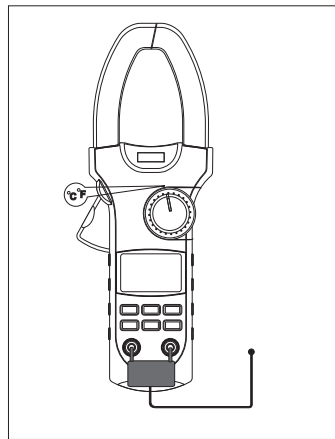

Figure 11

Note

- When the Meter is at °C range, it beeps to remind user to insert temperature probe.
- The Meter automatically displays the room temperature when the temperature probe is inserted but without any input.
- The included point contact temperature probe can only be used up to 230°C. For any measurement is higher than that, the rod type temperature probe must be used.
- When the temperature measurement has been completed, disconnect the connection between the temperature probe and the object under test, and remove the temperature probe away from the input terminals of the Meter.

Sleep Mode

To preserve battery life, the Meter automatically turns off if you do not turn the rotary switch or press any button for around 15 minutes.

The Meter beeps 3 times in one minute before entering Sleep Mode and long beep one time just before entering Sleep Mode.

The Meter can be activated by turning the rotary switch or pressing the button based on “**The Effectiveness of Functional Buttons**” on page 14

If the Meter is activated by pressing button, the Meter will keep the measurement value before entering Sleep Mode.

Press **MAX/MIN**, **LIGHT** or **Hz** to turn on the Meter can disable the Sleep Mode feature.

Specifications

A. General Specifications:

- Maximum Voltage between any Terminals and grounding: Refer to different range input protection voltage.
- Display: 3 5/6 digits LCD display, Maximum display 6666.
- Polarity: Auto
- Overloading: Display **OL** or **-OL**.
- Battery Deficiency: Display .
- Sampling: 3 times per second.
- Measurement Deviation: The conductor being measured is not placed in the center of the jaw during AC/DC current measurement, it will cause extra $\pm 1\%$ deviation based on the stated accuracy.
- Drop Test: 1 meter drop test passed.
- Max. Jaw Size: 55mm diameter.
- Projected Max. Current conductor size: 45mm diameter.
- Electro-Magnetic: When carrying out measurement near the electro-magnetic, it may cause unstable or wrong reading.
- Power: 1 x 9V battery (6LF22 1604A)

Model UT207/208: OPERATING MANUAL

- Battery Life: typically 150 hours (alkaline battery)
- Dimensions: 285.3mm x 105mm x 44.5mm
- Weight: Approximate 533g (battery included)

B. Environmental Requirements

- The Meter is suitable for indoor use.
- Altitude: Operating: 2000m
Storage: 10000m
- Safety/ Compliances: IEC61010-1; IEC61010-2-032. CAT.II 600V, CAT.III 300V over voltage and double insulation standard, pollution degree 2.
- Temperature and humidity:
 - Operating:
 - 0°C~30°C (≤80%R.H)
 - 30°C~40°C (≤75%R.H)
 - 40°C~50°C (≤45%R.H)
 - Storage:
 - 20°C~+60°C (≤80%R.H)

Accurate Specifications

Accuracy: \pm (a% reading + b digits), guarantee for 1 year.

Operating temperature: $23^{\circ}\text{C} \pm 5^{\circ}\text{C}$

Relative humidity: $\leq 80\% \text{R.H}$

Temperature coefficient: $0.1 \times (\text{specified accuracy}) / 1^{\circ}\text{C}$

A. DC Voltage

Range	Resolution	Accuracy	Overload protection
6.600V	1mV	$\pm (0.8\%+1)$	600V DC/AC
66.00V	10mV		
600.0V	100mV		

Remark: Input Impedance: $10\text{M}\Omega$

B. AC Voltage

Range	Resolution	Accuracy	Overload protection
6.600V	1mV	± (1.2%+5)	600V DC/AC
66.00V	10mV		
600.0V	100mV		

Remarks:

- Input Impedance: 10MΩ
- Frequency Response: 40Hz~400Hz
- Change to AC:
Combine AC and True RMS response method. Input sine wave to adjust. Non sine wave must follow the below data to adjust:
Peak factor: 1.4~2.0, add 1.0% on the stated accuracy
Peak factor: 2.0~2.5, add 2.5% on the stated accuracy
Peak factor: 2.5~3.0, add 4.0% on the stated accuracy.

C. Resistance

Range	Resolution	Accuracy	Overload protection
660.0Ω	0.1Ω	± (1.2%+2)	250VAC
6.600kΩ	1Ω	± (1%+2)	
66.00kΩ	10Ω		
660.0kΩ	100Ω		
6.600MΩ	1kΩ	± (1.2%+2)	
66.00MΩ	10kΩ	± (1.5%+2)	

D. Diode Test

Range	Resolution	Accuracy	Overload protection
	1mV	0.5V~0.8V (Open circuit voltage approx. 3.0V)	250VAC

E. Continuity Test

Range	Resolution	Accuracy	Overload protection
•)	0.1 Ω	Around $\leq 30\Omega$, the buzzer beeps. (Open circuit voltage approx. -1.2V)	250VAC

Remark:

- The buzzer may or may not beeps when the resistance of a circuit under test is between 30 Ω ~100 Ω .
- The buzzer does not beep when the resistance of a circuit under test is > 100 Ω

F. Frequency

Range	Resolution	Accuracy	Overload protection
660.0Hz	0.1Hz	± (0.1%+3)	250VAC
6.600kHz	0.001kHz		
66.00kHz	0.01kHz		
660.0kHz	0.1kHz		
6.600MHz	0.001MHz		
66.00MHz	0.01MHz		

Remarks:

Input Sensitivity (a) as follows:

When $a \leq 10\text{Hz}$: the Meter does not response

When $10\text{Hz} < a \leq 100\text{kHz}$: $\geq 300\text{mV rms}$

When $a > 100\text{kHz}$: $\geq 600\text{mV rms}$

Model UT207/208: OPERATING MANUAL

G. Duty Cycle

Range	Resolution	Accuracy	Overload protection
0.1%~99.9%	0.1%	For reference only	250VAC

H. DC Current

Range	Resolution	Accuracy	Overload protection
66.00A	0.01A	$\pm (2\%+40)$	250VAC
1000A	1A	$\pm (2\%+8)$	

 Warning

The operating temperature must be 0°C ~ 40°C when measuring current.

Remarks:

- If the reading is positive, the current direction is from bottom to up. See figure 10, the front case face up while the bottom case face down. Hold the Meter tight, do not release. The Hall components are very sensitive not only to the magnet but also to heat and machines reaction force. Any shock will cause the changing in reading in the short time. Follow the below procedure to measure current will be more precise:
 1. Turn off the current of tested conductor.
 2. Hold the Meter tight and press the lever to open the transformer jaw. Center the conductor within the transformer jaws, then release the Meter slowly until the transformer jaw is completely closed. Make sure the conductor to be tested is placed at the center of the transformer jaw, otherwise it will cause +1.0% deviation based on the stated accuracy.
 3. Press **ZERO** button to display zero.
 4. Turn on the current of tested conductor reading the stable value of clamp meter.
 5. The obtained reading will be more precise.

I. AC Current

Range	Resolution	Accuracy	Frequency Response	Overload protection
66.00A	0.01A	$\pm (2\%+40)$	50Hz ~ 60Hz	250VAC
1000A	1A	$\pm (2\%+8)$		

 Warning

The operating temperature must be 0°C ~40°C when measuring current.

Remarks:

- It may have unstable or wrong sensed readings, it will not affect measurement result.
- Hold the Meter tight, do not release. The Hall components are very sensitive not only to the magnet but also to heat and machines reaction force. Any shock will cause the changing in reading in the short time.
- Change to AC:
Combine AC and True RMS response method. Input sine wave to adjust.

Non sine wave must follow the below data to adjust:
 Peak factor: 1.4~2.0, add 1.0% on the stated accuracy.
 Peak factor: 2.0~2.5, add 2.5% on the stated accuracy
 Peak factor: 2.5~3.0, add 4.0% on the stated accuracy.

J. Temperature (UT208 only)

Range	Resolution	Accuracy	Overload protection
40°C~1000°C	1°C	-40°C~0°C: $\pm(3\%+4)$	250VAC
		0°C~400°C: $\pm(1\%+3)$	
		400°C~1000°C: $\pm(2\%+10)$	
-40°F~1832°F	1°F	-40°F~32°F: $\pm(3\%+8)$	
		32°F~752°F: $\pm(1\%+6)$	
		752°F~1832°F: $\pm(2\%+18)$	

MAINTENANCE

This section provides basic maintenance information including battery replacement instruction.

Warning

Do not attempt to repair or service your Meter unless you are qualified to do so and have the relevant calibration, performance test, and service information.

To avoid electrical shock or damage to the Meter, do not get water inside the case.

A. General Service

- Periodically wipe the case with a damp cloth and mild detergent. Do not use abrasives or solvents.
- To clean the terminals with cotton bar with detergent, as dirt or moisture in the terminals can affect readings.
- Turn the Meter power off when it is not in use.
- Take out the battery when it is not using for a long time.
- Do not use or store the Meter in a place of humidity, high temperature, explosive, inflammable and strong magnetic field.

B. Replacing the Battery (see figure 12)

Warning

To avoid false readings, which could lead to possible electric shock or personal injury, replace the battery as soon as the battery indicator “” appears.

Make sure the transformer jaw and the tets leads are disconnected from the circuit being tested before opening the case bottom.

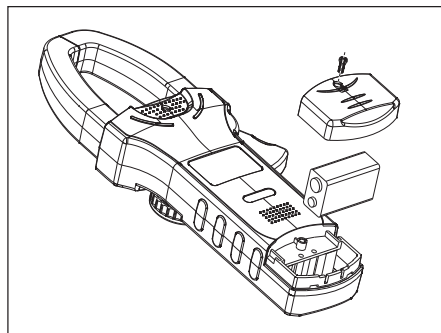

Figure 12

To replace the battery:

1. Turn the Meter off and remove all the connections from the input terminals
2. Turn the Meter's front case down.
3. Remove the screw from the battery compartment, and separate the battery compartment from the case bottom.
4. Take out the old battery and replace with a new 9V battery (6LF22, 1604A).
5. Rejoin the case bottom and the battery compartment, and reinstall the screw.

*** END ***

This operating manual is subject to change without notice.

©Copyright 2007 Uni-Trend Group Limited.
All rights reserved.

Manufacturer:
Uni-Trend Technology (Dongguan) Limited
Dong Fang Da Dao
Bei Shan Dong Fang Industrial Development District
Hu Men Town, Dongguan City Guang Dong Province
China
Postal Code: 523 925

Headquarters:
Uni-Trend Group Limited
Rm901, 9/F, Nanyang Plaza
57 Hung To Road Kwun Tong Kowloon, Hong Kong
Tel: (852) 2950 9168
Fax: (852) 2950 9303
Email: info@uni-trend.com
<http://www.uni-trend.com>