

Table of Contents

Title	Page
Overview	3
Unpacking Inspection	4
Safety Information	5
Rules for Safe Operation	6
International Electrical Symbols	9
The Meter Structure	10
Display Symbols	11
Functional Buttons	13
The Effectiveness of Functional Buttons	15
Measurement Operation	16
A. DC/AC Voltage Measurement	16
B. Measuring Resistance	18
C. Testing for Continuity	20
D. Testing Diodes	22
E. Frequency and Duty Cycle Measurement	25
F. DC/AC Current Measurement	27
G. Temperature Measurement(UT208A only)	31
H. Capacitance measurement(UT208A only)	33

Specifications	35
A. General Specifications	35
B. Environmental Requirements	36
Accuracy Specifications	37
Maintenance	43
A. General Service	43
B. Replacing the Battery	44

Overview

This Operating Manual covers information on safety and cautions. Please read the relevant information carefully and observe all the Warnings and Notes strictly.



Warning

To avoid electric shock or personal injury, read the “Safety Information” and “Rules for Safe Operation” carefully before using the Meter.

Digital Clamp Multimeter Model UT207A/UT208A/UT209A (hereafter referred to as “the Meter”) are 3 3/4 digits with steady operations, fashionable structure and highly reliable measuring instrument. The Meter uses large scale of integrated circuit with double integrated A/D converter as its core and has full range overload protection.

The Meter can measure AC/DC Voltage, AC/DC Current, Frequency, Duty Cycle, Resistance, Diodes, Continuity and etc.

UT208A has an extra temperature and Capacitance feature.

Unpacking Inspection

Open the package case and take out the Meter. Check the following items carefully to see any missing or damaged part:

Item	Description	Qty
1	English Operating Manual	1 piece
2	Test Lead	1 pair
3	Point Contact Temperature Probe (Only UT208A) (This included point contact temperature probe can only be used up to 230°C. For any measurement is higher than that, the rod type temperature probe must be used)	1 pair
4	Tool box	1 piece
5	9V Battery (NEDA1604A or 6LF22)	1 piece

In the event you find any missing or damage, please contact your dealer immediately.

Safety Information

This Meter complies with the standards IEC61010: in pollution degree 2, overvoltage category (CAT II 600V, CAT III 300V) and double insulation.

CAT II: Local level, appliance, PORTABLE EQUIPMENT etc., with smaller transient overvoltages than CAT III.

CAT III: Distribution level, fixed installation, with smaller transient overvoltages than CAT IV.

Use the Meter only as specified in this operating manual, otherwise the protection provided by the Meter may be impaired.

In this manual, a Warning identifies conditions and actions that pose hazards to the user, or may damage the Meter or the equipment under test.

A Note identifies the information that user should pay attention to.

International electrical symbols used on the Meter and in this Operating Manual are explained on page 9.

Rules for Safe Operation



Warning

To avoid possible electric shock or personal injury, and to avoid possible damage to the Meter or to the equipment under test, adhere to the following rules:

- Before using the Meter inspect the case. Do not use the Meter if it is damaged or the case (or part of the case) is removed. Look for cracks or missing plastic. Pay attention to the insulation around the connectors.
- Inspect the test leads for damaged insulation or exposed metal. Check the test leads for continuity. Replace damaged test leads with identical model number or electrical specifications before using the Meter.
- Do not apply more than the rated voltage, as marked on the Meter, between the terminals or between any terminal and grounding. If the value to be measured is unknown, use the maximum measurement position and reduce the range step by step until a satisfactory reading is obtained.
- When measurement has been completed, disconnect the connection between the test leads and the circuit under test, remove the testing leads away from the input terminals of the Meter and turn the Meter power off.
- The rotary switch should be placed in the right position and no any











changeover of range shall be made during measurement is conducted to prevent damage of the Meter.

- Do not carry out the measurement when the Meter's back case and battery compartment are not closed to avoid electric shock.
- Do not input higher than 1000V in DC or 750 V in AC between the two Meter's input terminal to avoid electric shock and damages to the Meter.
- When the Meter working at an effective voltage over 70V in DC or 33V rms in AC, special care should be taken for there is danger of electric shock.
- Use the proper terminals, function, and range for your measurements.
- Do not use or store the Meter in an environment of high temperature, humidity, explosive, inflammable and strong magnetic field. The performance of the Meter may deteriorate after dampened.
- When using the test leads, keep your fingers behind the finger guards.
- To avoid electric shock, do not touch the bare wires, connectors, unused input terminals or the circuit under testing during measurement.
- Disconnect circuit power and discharge all high-voltage capacitors before testing resistance, continuity and diode.
- Replace the battery as soon as the battery indicator  appears. With a low battery, the Meter might produce false readings that can lead to electric shock and personal injury.
- When servicing the Meter, use only the same model number or identical

electrical specifications replacement parts.

- The internal circuit of the Meter shall not be altered at will to avoid damage of the Meter and any accident.
- Soft cloth and mild detergent should be used to clean the surface of the Meter when servicing. No abrasive and solvent should be used to prevent the surface of the Meter from corrosion, damage and accident.
- The Meter is suitable for indoor use.
- Turn the Meter off when it is not in use and take out the battery when not using for a long time.
- Constantly check the battery as it may leak when it has been using for some time, replace the battery as soon as leaking appears. A leaking battery will damage the Meter.

International Electrical Symbols

	Double Insulated
	Grounding
	Warning. Refer to the Operating Manual
	AC (Alternating Current)
	DC (Direct Current)
	Continuity Test
	Diode
	Deficiency of Built-In Battery
	AC or DC
	Danger of High Voltage
	Conforms to Standards of European Union

The Meter Structure (see figure 1)

- ① Hand Guards: to protect user's hand from touching the dangerous area.
- ② Trigger: press the lever to open the transformer jaws. When the pressure on the lever is released, the jaws will close.
- ③ Functional Buttons
- ④ Input Terminals
- ⑤ LCD Display
- ⑥ Rotary Switch
- ⑦ Transformer Jaw: designed to pick up the AC and DC current flowing through the conductor. It could transfer current to voltage. The tested conductor must vertically go through the Jaw center.

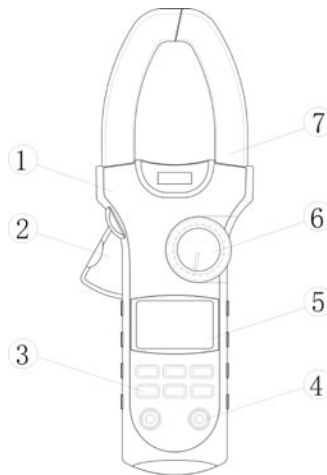

Figure 1

Display Symbols (see figure 2)

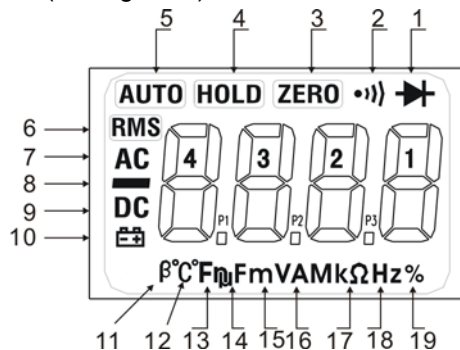

Figure 2

1. Test of diode
2. The continuity buzzer is on
3. Indicator for zeroing
4. Data hold is active
5. The Meter is in the auto range mode in which the Meter automatically selects the range with the best resolution.

6. True RMS indicator
7. Indicator for AC voltage or current
8. Indicates negative reading
9. Indicator for DC voltage
10. The battery is low.

Warning: To avoid false readings, which could lead to possible electric shock or personal injury, replace the battery as soon as the battery indicator appears.

11. The unit of transistor hEF
12. The unit of temperature, °C: Centigrade temperature
13. The unit of temperature, °F: Fahrenheit temperature
14. The unit of capacitance (UT208A only)
15. Volts. The unit of voltage. mV: Millivolt.
16. Amperes (amps). The unit of current.
17. The unit of resistance. (Ω : Ohm, k Ω :Kilohm, M Ω :Megohm)
18. The unit of frequency. (Hz: Hertz, KHz: Kilohertz, MHz: Meghertz)
19. Duty cycle measurement

Functional Buttons

Below table indicated for information about the functional button operations.

Button	Operation Performed
SELECT	Press SELECT button to select the alternate functions including V_{AC} , A_{AC} and $\rightarrow \Omega$. ($\rightarrow \Omega$ UT208A only)
RANGE	Range feature: Exit AUTO and enter MANUAL ranging. In MANUAL, select next input range. EXIT to return to AUTO. AUTO is default.
	Press once to turn the display backlight on. Press again to turn the display backlight off, otherwise it will automatically off after 15 seconds.
HOLD	<ul style="list-style-type: none"> • Press HOLD to enter the Hold mode in any mode (except %Hz), the Meter beeps. • Press HOLD again to exit the Hold mode to return to measurement mode, the Meter beeps. • Turn the rotary switch or press any button can also exit hold mode.







⌘Hz%	When the Meter is at ⌘%Hz, V $\overline{\sim}$ and A $\overline{\sim}$, press ⌘%Hz to measure frequency and duty cycle.
ZERO	Press ZERO to zeroing the display before measuring AC/DC voltage, AC/DC current, resistance and capacitance.

Automatic Power Off

The display blanks and the Meter goes into a “sleep” mode if you have not changed the rotary switch position or pressed a button for 15 minutes. While in Sleep mode, pressing the any effective Functional button or turning the rotary switch could turn the Meter on. To disable the sleep mode function, press SELECT button while turning on the meter.

The Effectiveness of Functional Buttons

Not every functional buttons can be used on every rotary switch positions. Below table describe which functional buttons can be used on which rotary switch positions.

Rotary Switch Positions	Functional Buttons					
	SELECT	RANGE		HOLD	 %Hz	ZERO
V 	●	●	●	●	●	●
	●	N/A	●	●	N/A	●
Ω	N/A	●	●	●	N/A	●
%Hz	N/A	N/A	●	N/A	●	N/A
40A 	●	N/A	●	●	●	●
400A 	●	N/A	●	●	●	●
1000A 	●	N/A	●	●	●	●
$^{\circ}\text{C}$	N/A	N/A	●	●	N/A	N/A

Measurement Operation

A. DC/AC Voltage Measurement (see figure 3)

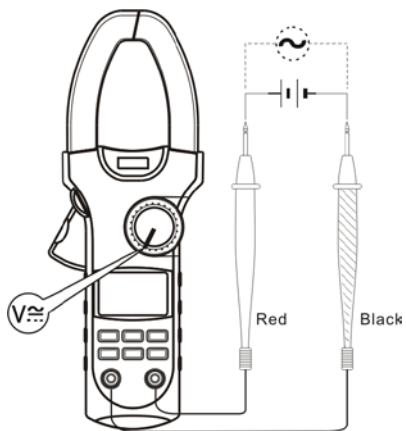

Figure 3

⚠ Warning

To avoid harms to you or damages to the Meter from electric shock, do not attempt to measure voltages higher than 750V AC or 1000V DC, although readings may be obtained.

To measure DC/AC voltages, connect the Meter as follows:

1. Insert the red test lead into the **VΩHz** terminal and black test lead into the **COM** terminal.
2. Set the rotary switch to $V \approx$. DC measurement mode is a default. Press **SELECT** to switch to AC measurement mode. Press **RANGE** to enter manual ranging.
3. Press $\text{Hz}\%$ button to measure frequency or duty cycle, but the frequency or duty cycle readings obtained from this range is only for reference.
4. Connect the test leads across with the object being measured. The measured value shows on the display.

Note:

- AC Millivolt is a manual ranging measurement mode.
- In each range, the Meter has an input impedance of 10MΩ. This loading effect can cause measurement errors in high impedance circuits. If the

circuit impedance is less than or equal to 10k Ω , the error is negligible (0.1% or less).

- When DC/AC voltage measurement has been completed, disconnect the connection between the testing leads and the circuit under test and remove testing leads from the input terminals.

B. Measuring Resistance (see figure 4)

Warning

To avoid damages to the Meter or to the devices under test, disconnect circuit power and discharge all the high-voltage capacitors before measuring resistance.

To measure resistance, connect the Meter as follows:

1. Insert the red test lead into the **V Ω H Ω** terminal and black test lead into the **COM** terminal.
2. Set the rotary switch to **Ω**
3. Connect the test leads across with the object being measured. The measured value shows on the display.

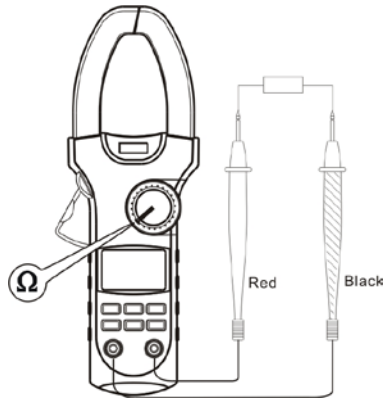

Figure 4

Note:

- To obtain a more precise reading, you could remove the objects being tested from the circuit when measuring.
- The test leads can add 0.1Ω to 0.3Ω of error to resistance measurement. To obtain precision readings in low-resistance measurement, short-circuit the

input terminals beforehand, press **ZERO** to automatically subtract the value measured when the testing leads are short-circuited from the reading.



- For high-resistance measurement ($>1\text{M}\Omega$), it is normal to take several seconds to obtain a stable reading.
- To avoid harms to you or damages to the Meter from electric shock, do not attempt to input voltages higher than 33V AC or 70V DC.
- When resistance measurement has been completed, disconnect the connection between the testing leads and the circuit under test and remove testing leads from the input terminals.

Testing for Continuity (see figure 5)

Warning

To avoid damages to the Meter or to the devices under test, disconnect circuit power and discharge all the high-voltage capacitors before measuring continuity.

To test for continuity, connect the Meter as follows:

1. Insert the red test lead into the **VΩHz** terminal and the black test lead into the **COM** terminal.
2. Set the rotary switch to  and press **SELECT** button to select 

measurement mode.

3. The buzzer sounds if the resistance of a circuit under test is less than 10Ω .
4. The buzzer may or may not sound if the resistance of a circuit under test is between 10Ω to 100Ω .
5. The buzzer does not sound if the resistance of a circuit under test is higher than 100Ω .

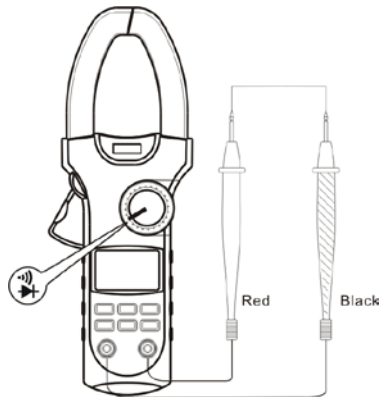

Figure 5

Note

- To avoid harms to you or damages to the Meter from electric shock, do not attempt to input voltages higher than 33V AC or 70V DC.
- When continuity testing has been completed, disconnect the connection between the testing leads and the circuit under test and remove testing leads from the input terminals.

D. Testing Diodes (see figure 6)



Warning

To avoid damages to the Meter or to the devices under test, disconnect circuit power and discharge all the high-voltage capacitors before testing diodes.

Use the diode test to check diodes, transistors, and other semiconductor devices. The diode test sends a current through the semiconductor junction, then measure the voltage drop across the junction. A good silicon junction drops between 0.5V and 0.8V.

To test the diode out of a circuit, connect the Meter as follows:

1. Insert the red test lead into the **VΩHz** terminal and black test lead into the **COM** terminal.
2. Set the rotary switch to \rightarrow . Press **SELECT** to switch to \rightarrow measurement mode. For forward voltage drop readings on any semiconductor component, place the red test lead on the component's anode and place the black test lead on the component's cathode. The LCD will display **OL** indicating diode being tested is open or polarity error display.

Note

- To obtain a more precise reading, you could remove the objects being tested from the circuit when measuring.
- To avoid harms to you or damages to the Meter from electric shock, do not attempt to input voltages higher than 33V AC or 70V DC.
- When diode testing has been completed, disconnect the connection between the testing leads and the circuit under test and remove testing leads from the input terminals.

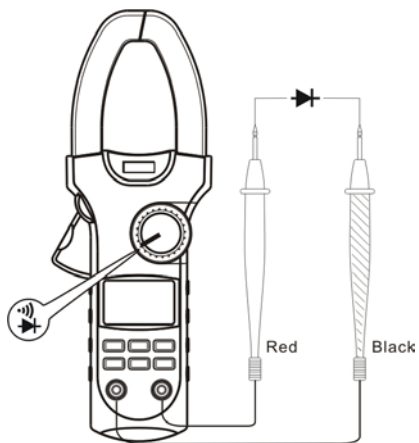

Figure 6

E. Frequency and Duty Cycle Measurement (see figure 7)

Warning

To avoid harms to you or damages to the Meter from electric shock, do not attempt to measure voltages higher than 750V AC or 1000V DC, although readings may be obtained.

To measure frequency, connect the Meter as follows:

1. Insert the red test lead into the **VΩHz** terminal and the black test lead into the **COM** terminal.
2. Set the rotary switch to %Hz. Frequency measurement mode is a default or press $\text{f}\%$ Hz button to switch to duty cycle measurement mode.
3. Connect the test leads across with the object being measured. The measured value shows on the display.

Note:

When frequency measurement has been completed, disconnect the connection between the testing leads and the circuit under test, and remove the testing leads away from the input terminals of the Meter.

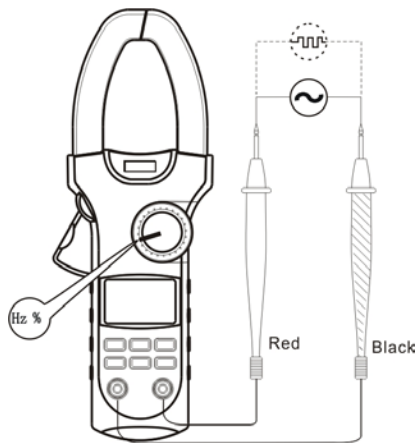

Figure 7

F. DC/AC Current Measurement (see figure 8)

Warning

The operating temperature must be 0°C ~40°C when measuring current.

To measure current, do the following:

1. Set the rotary switch to 40A \approx , 400A \approx , or 1000A \approx . DC measurement mode is a default. Press **SELECT** to switch to AC measurement mode.
2. Hold the Meter tight, don't release.
3. Press the lever to open the transformer jaw.
4. Center the conductor within the transformer jaw, then release the Meter slowly until the transformer jaw is completely closed, Make sure the conductor to be tested is placed at the center of the transformer jaw, otherwise it will cause deviation. The Meter can only measure one conductor at a time, to measure more than one conductor at a time will cause deviation.

Note for DC measure:

- The Hall components are very sensitive not only to the magnet but also to heat and machines reaction force. Any shock will cause the changing in reading in the short time.
- When the Meter does not display 0 before measurement, press **ZERO** to



Figure 8

zeroing.

- Center the conductor within the transformer jaw, then release the Meter slowly until the transformer jaw is completely closed. Make sure the conductor to be tested is placed at the center of the transformer jaw, otherwise it will cause ± 1.0 % deviation.
- When measuring DC current, if the reading is positive, then the current direction is from up to down (see figure 8: the front case face up while the bottom case face down).

Below testng method can obtain more accurate DC current:

- Power off the tested conductor current,
- Press the lever to open the transformer jaw.
- When the reading is stabled at the minimal, press ZERO to display zero
- Power on the tested conductor current, read out the reading after the Meter is stable.

Note for AC measure

- Center the conductor within the transformer jaw, then release the Meter slowly until the transformer jaw is completely closed. Make sure the conductor to be tested is placed at the center of the transformer jaw, otherwise it will cause ± 1.0 % deviation.

- The meter will zero automatically.
- When the measuring current $>1A$, press Hz button to toggle between AC current and frequency measurement mode. But the frequency readings obtained from this range is only for reference.
- Change to AC:
UT207A/208A: Couple AC and average value response method. UT209A: Couple AC and True RMS response method. Input sine wave to adjust. Non sine wave must follow the below data to adjust:
Peak factor: 1.4~2.0, add 1.0% on the stated accuracy.
Peak factor: 2.0~2.5, add 2.5% on the stated accuracy
Peak factor: 2.5~3.0, add 4.0% on the stated accuracy.

G. Temperature Measurement (UT208A only, see figure 9)

To measure temperature measurement, connect the Meter as follows:

1. Insert the red temperature probe into the **VΩHz** terminal and the black temperature probe into the **COM** terminal.
2. Set the rotary switch to °C measurement mode.
3. Place the temperature probe to the object being measured. The measured value shows on the display.

Note

- When the Meter is at °C range, display “**OL**” to remind user to insert temperature probe.
- The Meter automatically displays the room temperature when the temperature probe is inserted but without any input.
- The included point contact temperature probe can only be used up to 230°C. For any measurement is higher than that, the rod type temperature probe must be used.
- When the temperature measurement has been completed, disconnect the connection between the temperature probe and the object under test, and remove the temperature probe away from the input terminals of the Meter.

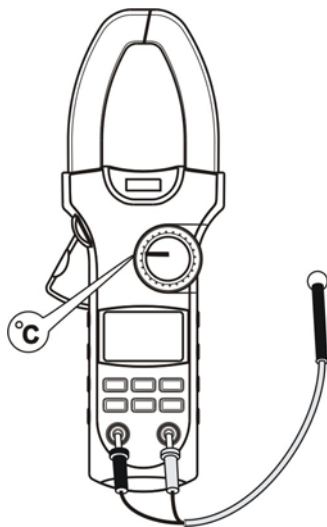

Figure 9

H. Capacitance measurement (UT208A only, see figure 10)

⚠ To avoid harms to you or damages to the Meter from electric shock, do not attempt to input voltages higher than 33V AC or 70V DC.

To measure capacitance, do the following:

1. Insert the red test lead into the **VΩHz** input terminal and black test lead to the **COM** input terminal.
2. Set the rotary switch to $\rightarrow \text{H} \rightarrow \Omega$ measurement mode. Press the select button switch to H -measurement mode, To improve the measurement accuracy of small value capacitors (less than 10nF), press zero with the test leads open to subtract the residual capacitance of the Meter and leads.
3. It is recommended to use test clip to carry out measurement to reduce the effect of internal distributed capacitor.

Note:

- Disconnect circuit power and discharge all high-voltage capacitors before testing Capacitors.
- When capacitance measurement has been completed, disconnect the connection between the testing leads and the circuit under test and remove the test leads away from the input terminals of the Meter.

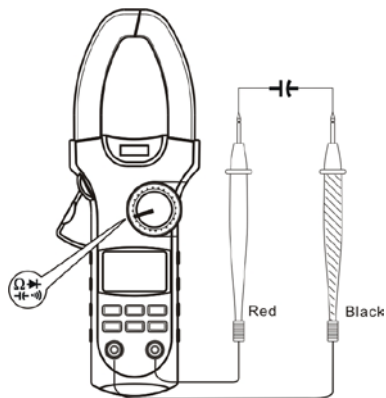

Figure 10

Specifications

A. General Specifications:

- Display: 3 3/4 digits LCD display, Maximum display 3999.
- Polarity: Auto
- Overloading: Display **OL** or **-OL**.
- Battery Deficiency: Display **⚡**.
- Sampling: 3 times per second.
- Measurement Deviation: The conductor being measured is not placed in the center of the jaw during AC/DC current measurement, it will cause extra $\pm 1\%$ deviation based on the stated accuracy.
- Drop Test: 1 meter drop test passed.
- Max. Jaw Size: 55mm diameter.
- Projected Max. Current conductor size: 45mm diameter.
- Electro-Magnetic: When carrying out measurement near the electro-magnetic, it may cause unstable or wrong reading.
- Power: 1 x 9V battery (6LF22 1604A)
- Dimensions: 285.3mm x 105mm x 44.5mm
- Weight: Approximate 533g (battery included)

B. Environmental Requirements

- The Meter is suitable for indoor use.
- Altitude: Operating: 2000m
Storage: 10000m
- Safety/ Compliances: IEC 61010 CATII 600V, CATIII 300V over voltage and double insulation standard, pollution degree 2.
- Temperature and humidity:
Operating:
 - 0°C~30°C (≤85%R.H)
 - 30°C~40°C (≤75%R.H)
 - 40°C~50°C (≤45%R.H)Storage:
 - 20°C~+60°C (≤85%R.H)

Accurate Specifications

Accuracy: $\pm(a\% \text{ reading} + b \text{ digits})$, guarantee for 1 year.

Operating temperature: $23^{\circ}\text{C} \pm 5^{\circ}\text{C}$

Relative humidity: $\leq 80\% \text{R.H}$

Temperature coefficient: $0.1 \times (\text{specified accuracy}) / 1^{\circ}\text{C}$

A. DC Voltage

Range	Resolution	Accuracy	Overload protection
400mV	0.1mV	$\pm(0.8\%+3)$	DC1000V/AC750V
4V	0.001mV	$\pm(0.8\%+1)$	
40V	0.01V		
400V	0.1V		
1000V	1V	$\pm(1.0\%+3)$	

Remark: Input Impedance: $10\text{M}\Omega$.

B. AC Voltage

Range	Resolution	Accuracy	Overload protection
400mV	0.1mV	$\pm(1.2\%+20)$	DC1000V/AC750V
4V	0.001mV	$\pm(1.2\%+3)$	
40V	0.01V		
400V	0.1V		
750V	1V	$\pm(1.2\%+5)$	

Remarks:

- Input Impedance: 10M Ω
- Frequency Response: 40Hz~400Hz
- Change to AC:
 - UT207A/208A: Couple AC and average value response method. UT209A: Couple AC and True RMS response method. Input sine wave to adjust. Non sine wave must follow the below data to adjust:
 - Peak factor: 1.4~2.0, add 1.0% on the stated accuracy
 - Peak factor: 2.0~2.5, add 2.5% on the stated accuracy
 - Peak factor: 2.5~3.0, add 4.0% on the stated accuracy.

C. Resistance

Range	Resolution	Accuracy	Overload protection
400 Ω	0.1 Ω	$\pm(1.2\%+2)$	DC1000V/AC750V
4k Ω	0.001K Ω	$\pm(1.0\%+2)$	
40k Ω	0.01K Ω		
400k Ω	0.1K Ω		
4M Ω	0.001M Ω	$\pm(1.2\%+2)$	
40M Ω	0.01M Ω	$\pm(1.5\%+2)$	

D. Continuity Test

Range	Resolution	Accuracy	Overload Protection
	0.1 Ω	Around $\leq 10 \Omega$, the buzzer beeps. (Open circuit voltage approx 0.4V)	DC1000V /AC750V

Remarks:

- The buzzer beep when the resistance of a circuit under test is $< 10 \Omega$.
- The buzzer may or may not beeps when the resistance of a circuit $> 10 \Omega$

E. Diode Test

Range	Resolution	Accuracy	Overload Protection
	1mV	0.5V~0.8V (Open circuit voltage approx. 1.5V)	DC1000V /AC750V

F. Frequency

Range	Resolution	Accuracy	Overload Protection
400Hz	0.1Hz	±(0.1%+3)	DC1000V/AC750V
4kHz	0.001kHz		
40kHz	0.01kHz		
400kHz	0.1kHz		
4MHz	0.001MHz		
40MHz	0.01MHz		

Remarks:

Input Sensitivity as follows:

When ≤ 100kHz: ≥ 300mV rms

When > 100kHz: ≥ 600mV rms

Input amplitude a: 300mV ≤ a ≤ 10V rms

G. Duty Cycle

Range	Resolution	Accuracy	Overload Protection
0.1%~99.9%	0.1%	For reference only	DC1000V/AC750V

H. DC Current

Range	Resolution	Accuracy	Overload protection
40A	0.01A	$\pm(2.0\%+5)$	1000A DC/AC
400A	0.1A	$\pm(2.0\%+3)$	
1000A	1A	$\pm(1.5\%+5)$	

I. AC Current

Range	Resolution	Accuracy	Frequency Response	Overload protection
40A	0.01A	$\pm(2.5\%+8)$	50Hz ~ 60Hz	1000A DC/AC
400A	0.1A	$\pm(2.5\%+5)$		
1000A	0.1A	$\pm(2.0\%+2)$		

J. Temperature (UT208A only)

Range	Resolution	Accuracy	Overload Protection
-40°C~1000°C	1°C	-40°C~0°C: $-(8\%+5)$	1K Ω
		0°C~400°C: $\pm(2.5\%+3)$	
		400°C~1000°C: $\pm(3\%+3)$	

K. Capacitance(UT208A only)

Range	Resolution	Accuracy	Overload Protection
4nF	0.001nF	For reference only	DC1000V/AC750V
40nF	0.01nF	$\pm(4.0\%+3)$	
400nF	0.1nF		
4 μ F	0.001 μ F		
40 μ F	0.01 μ F	$\pm(5.0\%+10)$	
100mF	0.1 μ F		

Maintenance

This section provides basic maintenance information including battery replacement instruction.



Warning

Do not attempt to repair or service your Meter unless you are qualified to do so and have the relevant calibration, performance test, and service information.

To avoid electrical shock or damage to the Meter, do not get water inside the case.

A. General Service

- Periodically wipe the case with a damp cloth and mild detergent. Do not use abrasives or solvents.
- To clean the terminals with cotton bar with detergent, as dirt or moisture in the terminals can affect readings.
- Turn the Meter power off when it is not in use.
- Take out the battery when it is not using for a long time.
- Do not use or store the Meter in a place of humidity, high temperature, explosive, inflammable and strong magnetic field.

B. Replacing the Battery (see figure 11)



Warning

To avoid false readings, which could lead to possible electric shock or personal injury, replace the battery as soon as the battery indicator “” appears.

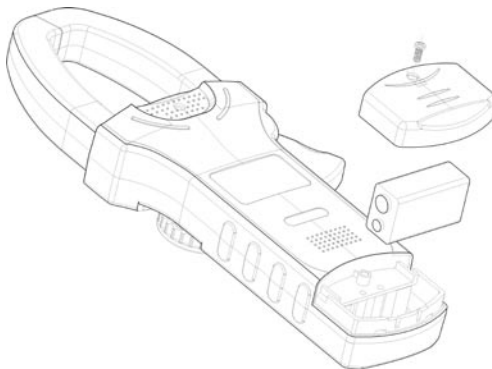

figure 11

Make sure the transformer jaw and the test leads are disconnected from the circuit being tested before opening the case bottom.

To replace the battery:

1. Turn the Meter off and remove all the connections from the input terminals
2. Turn the Meter's front case down.
3. Remove the screw from the battery compartment, and separate the battery compartment from the case bottom.
4. Take out the old battery and replace with a new 9V battery (6LF22, 1604A).
5. Rejoin the case bottom and the battery compartment, and reinstall the screw.

This operating manual is subject to change without notice



©Copyright 2010 Uni-Trend Group Limited.
All rights reserved.

Manufacturer:

Uni-Trend Technology (Dongguan) Limited
Dong Fang Da Dao
Bei Shan Dong Fang Industrial Development District
Hu Men Town, Dongguan City
Guang Dong Province
China
Postal Code: 523 925

Headquarters:

Uni-Trend Group Limited
Rm901, 9/F, Nanyang Plaza
57 Hung To Road
Kwun Tong
Kowloon, Hong Kong
Tel: (852) 2950 9168
Fax: (852) 2950 9303
Email: info@uni-trend.com
<http://www.uni-trend.com>